

Altema d.o.o.



KATALOG 2017/18

- PROFESIONALNI RUČNI ALAT
- SERVISNA OPREMA
- SISTEMI ZA EKSTRAKCIJU GASOVA



office@altema.rs

www.altema.rs

Ključevi svih vrsta sa trajnom garancijom



Ključevi brzi u garnituri



Ključevi inbus u garnituri



TRAJNA GARANCIJA NA USAG ALATE !!!

Ključevi sa T ručicom

Ključevi sa T ručicom



Udarni ojačani odvijači, sa prihvatom za ključ, izrađeni od kvalitetnog čelika, kaljeni



Odvijači svih vrsta ravni,krstasti,torx,nasadni



PROFESIONALNI RUČNI ALAT

Klešta svih vrsta i nemena



Klešta ekstra duga dvostruko zglobna prava i kriva

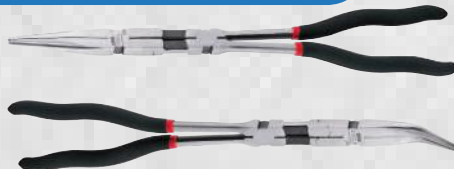

Grip klešta raznih oblika i dimenzija



Pincete svih oblika



Klešta za spoljašnje i unutrašnje seger osigurače prava i zakrivljena sa opsegom od 3 mm do 200 mm



Makaze električarske za sečenje kablova do 50 mm²



Klešta za zatezanje i odsecanje vezica bez oštih krajeva



Alat za skidanje tapacira i strugač registarskih nalepnica



Testera za metal sa ergonomskim rukohvatom



Limarska turpija - rašpa



Makaze za lim svih oblika i dimenzija



Držać ureznica svih dimenzija

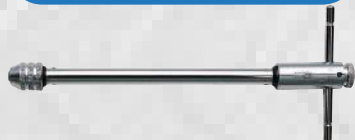

Izbijači i sekači u garnituri



Izvalakači zalomljenih vijaka



Držać narezica svih dimenzija



TRAJNA GARANCIJA NA USAG ALATE !!!

Alat za montažu karike cilindra



Lampa radionička zglobna magnetna sa čeonim svetlom, punjiva mase 260 gr



Lampa radionička ekstra tanka sa SMD LED tehnologijom, magnetna i punjiva, mehanički otporna na udarce, mase 160 gr



Stega bravarska sa otvorom do 150 mm, izrađena od ojačanog čelika



Mazalica sa fleksibilnim crevom



PROFESIONALNI RUČNI ALAT

Garnitura nasadnih ključeva sa ručicom i nastavcima u koferu



Ručica reverzibilna sa zaprivenim mehanizmom - trajna garancija



DUST PROOF



Garnitura nasadnih ključeva i bitova sa ručicama u koferu

Garnitura nasadnih ključeva sa ručicom i nastavcima u koferu Just USAG

Ručica teleskopska zlobna sa sedam pozicija dužine, ergonomski rukohvat, hromirana i matirana.



PROFESIONALNI AUTOMOTIVE ALAT !!!

Digitalni moment ključ sa prihvatom od 1/2" i opsegom od 6,8 Nm do 340 Nm

Moment ključevi sa ergonomskim rukohvatom i opsegom od 5Nm do 340 Nm



Ključevi nasadni duboki za skidanje točkova sa aluminijumskim felnama

Ključevi nasadni kovani svih profila (torx, inbus, xzn)

Specijalni ključevi sa različitim oblicima i prihvatom za sva vozila



TRAJNA GARANCIJA NA USAG ALATE !!!

Klešta jednoručna za pop nitne od 2,4 mm do 4,8 mm

Klešta dvoručna za pop nitne od 2,9 mm do 6 mm

Refraktometar za merenje osobina fluida



PROFESIONALNI AUTOMOTIVE ALAT !!!

Ključ za filtre brzi sa čegrtaljkom i sa metalnom trakom sa opsegom, od 66 mm do 150 mm



Ključ za demontažu čepa rezervoara goriva od 88 do 170 mm



Garnitura alata za skidanje tapacirunga



Garnitura ključeva filtera za ulje u koferu za sve tipove vozila



Ključ za filter ulja sa lancemsa opsegom od 50 mm do 110 mm



Teleskopsko ogledalce sa lampom



Hvataljka fleksibilna

Set za montažu/demontažu kaiševa



TRAJNA GARANCIJA NA USAG ALATE !!!

Pribor sa 10 alata za montažu/demontažu ventila pneumatika sa sistemom za kontrolu pritiska u pneumatiku



SVE VRSTE SPECIJALNIH KLEŠA



Radapciger za metlice brisača

Klešta za sečenje cevi auspuha, prečnika od 31 mm do 65 mm



Invertorski aparat za MMA/TIG zavarivanje, "vruć" automatski start, integrisana ventilacija, klasa zaštite IP21, kompaktan i lagan mase samo 4 kg

Viljuška za ispitivanje akumulatora i alternatora, 6V i 12V, masa 540 gr



Zaštita memorije na vozilima 12V/24V



Starter-booster za putnička i teretna vozila, 24V, udarna struja 2500A, dužina kablova 1700 mm, masa 19 kg



Radapciger za bočno ogledalo



Pneumatska univerzalna mašina za sabijanje opruga amortizera, samostalni podešavajući sistem

Crevo za vazduh sa spojnicama

Motalica sa crevom za vazduh



Dizalica hidraulična krokodil ekstra tanka za niskoprofilna vozila nosivosti 2T, kompaktna od poliamidnih neklizajućih točkova, mase 43 kg

Pištolj pneumatski za pop nitne



Pištolj pneumatski od titanijumske strukture, velikog obrtnog momenta, nizak nivo buke, izduh vazduha kroz rukohvat, MASA 1,3 kg

PROFESIONALNA OPREMA I ZAŠTITNA OBUĆA

Torba za alat sa vodootpornom površinom i metalnim ergonomskim rukohvatom i ojačanjem

Garnitura alata sa trajnom garancijom u aluminijumskom koferu, trostruka unutrašnjost za odlaganje alata. Ukupno 181 delova Just USAG

Garnitura alata u torbi sa metalnim okvirom i trakom za nošenje



Garnitura alata u rancu sa teleskopskim rukohvatom i točkićima, pregrada za računar

Torbica od kvalitetnog materijala sa alatom i kaišem



Zaštitna obuća izrađena od polietilena i gume otporne na ulje, bez metala, fleksibilna i lagana, kategorija zaštite S3



NA USAG ALATE DAJEMO TRAJNU GARANCIJU !!!

INDUSTRIJSKI KABINETI I OPREMA



GARNITURE ALATA U KOLICIMA

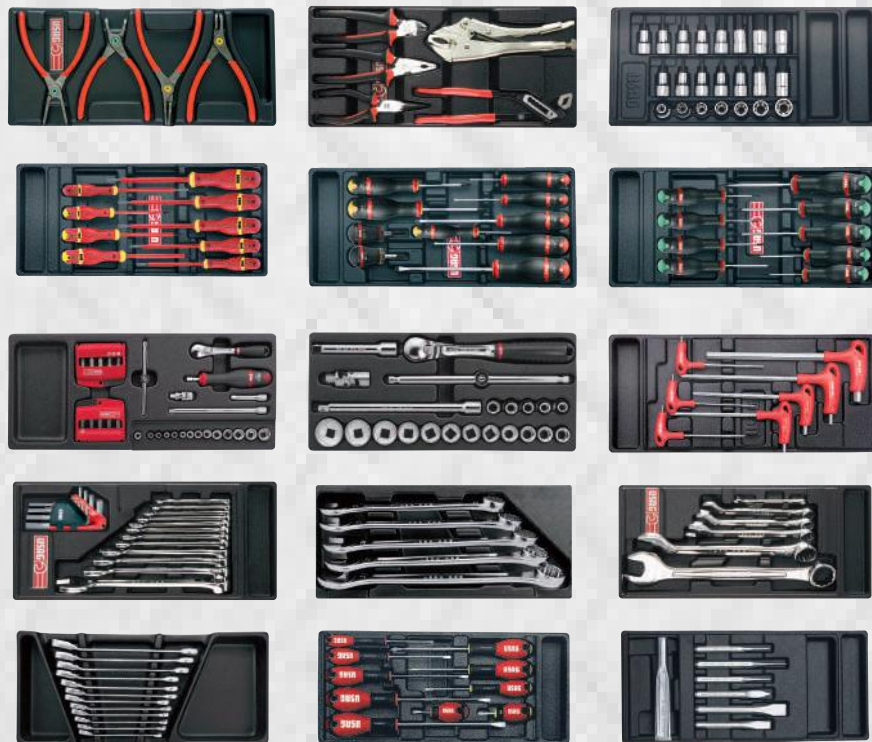

NA USAG ALATE DAJEMO TRAJNU GARANCIJU !!!

NEVARNIČEĆI ALAT

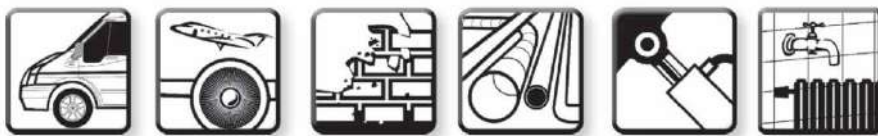

ŠIROKA PRIMENA NEVARNIČEĆEG ALATA PREDVIČENIM ZA RAD U EKSPLOZIVNIM SREDINAMA U INDUSTRIJI I GRAĐEVINARSTVU

TRI STANDARDA PROIZVODNJE NEVARNIČEĆEG ALATA

BERYLLIUM plus

LEGURA BAKRA I BERILIJUMA, VISOKA OTPORNOST NA HABANJE I KOROZIJU, OKALJEN



TITAN plus

LEGURA TITANIJUMA, NEMAGNETNI ALAT, OTPORAN NA KISELINE I KOROZIJU, VEOMA LAK MATERIJAL



BRONZE plus

LEGURA SREBRA I BRONZE, VISOKA OTPORNOST NA KOROZIJU I HABANJE



PROFESIONALNI RUČNI ALAT !!!

Garnitura bitova sa nastavcima, adapterima sa ručicom

Bitovi svih profila i prihvata sa adapterima i nosačima

Ključevi nasadni svih profila, oblika i prihvata, metrički i colovni, od kovanog i hromiranog čelika od 4 mm do 120 mm



Garniture bitova svih profila i klasa čelika u garniturama i pojedinačno sa ručicama



Odvijač fleksibilni sa ergonomskim rukohvatom i prihvatom za bitove raznih profila



MICRO

TITAN plus

TORION power

TIN Bits



PROFESIONALNI RUČNI ALAT !!!

Probna lampa za testiranje na vozilima



Radapcigeri hidraulični i ručni svih oblika i opsega



Merač debljine farbe digitalni sa LCD ekranom



Spoter autolimarski sa nastavcima i dodacima u koferu



Stepenaste burgije raznih vrsta čelika i dimenzija



Induktivni grejač sa regulacijom i izmjenjivim nastavcima različitih oblika, snažan i brzo dostiže željenu temperaturu

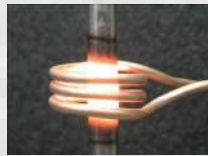

Merač dubine šare i pritiska kod pneumatika



PROFESIONALNI RUČNI ALAT !!!

Merač debljine diskova na vozilima

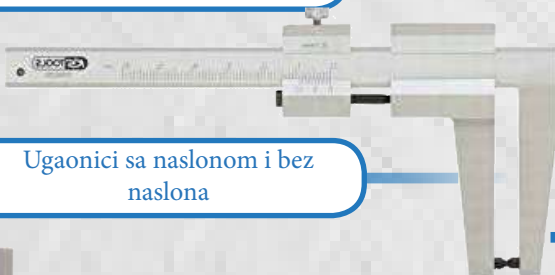

Merni listići za merenje zazora



Komparateri digitalni i analogni raznih oblika i opsega



Ugaonici sa naslonom i bez naslona



Pomična merila analogna i digitalna raznih opsega



Uglomeri svih opsega i oblika



Merne trake svih dužina



Lenjiri raznih dužina od kvalitetnih čelika



PROFESIONALNI RUČNI ALAT !!!

Dizalice hidraulične nosivosti od 2t do 30t

Klocne u paru nosivosti 3t i 6t

Dizalica hidraulična za ranžiranje točkova

Nosač motora sa lančanim prihvatom

Poluga za ispitivanje zazora balans štangle

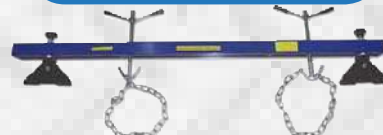

Analogni merač ugla - stepen ključ

Alat za montažu/demontažu letve volana

Klešta za šelne sa fleksibilnom sajmom

Alat za montažu/demontažu remenice klime



Ležaljka mobilna sklopiva

Pištolj za izduvavanje vazduha

Klešta za gumena creva

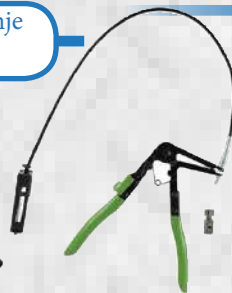

GARNITURE I SETOVI ALATA !!!

Specijalni alati za zupčenje svih vrsta motornih vozila

Pištolj za vakuumiranje vazduha sa manometrom

Garnitura profesionalnog alata u koferu

Poluga za ispitivanje zazora



Ključevi za zatezanje španera

Alati za ispitivanje kompresije na cilindrima motora

Set alata za montažu/demontažu injektora

Set alata za montažu/demontažu grejača



PROFESIONALNI PNEUMATSKI ALAT !!!

Mašina za reparaciju kočionog sistema - master cilindar, u koferu sa nastavcima za sve tipove vozila



Pneumatski pištolj NANO, kompaktan, malih dimenzija i mase



Pneumatske ručice svih jačina i prihvata



Dizalica kranska za podizanje motora i menjača nosivosti 2t



Uređaj za vakuumiranje i ubacivanje menjačkog ulja sa nastavcima u koferu



POTROŠNI MATERIJAL ZA INDUSTRIJSKU I AUTOMOTIV NAMENU

Sijalice svih vrsta za putnički i teretni program pojedinačno i u setovima



Set navlaka za sedišta, volan, ručice menjača, ručne kočnice, potosnica za pod



Rukavice nitrilne svih veličina visoke elastičnosti i kvaliteta



Industrijski papir Kimberly Clark



Lampa punjiva baterijska sa LED tehnologijom, magnetna sa ergonomskim rukohvatom

Lampa baterijska sa LED diodama, magnetna

Šelne svih dimenzija i oblika

Rukavice zaštitne od raznih materijala i veličina



Sprejevi svih vrsta i namena za industrijsku



Abrazivna pasta za pranje ruku



Zaštitna magnetna folija

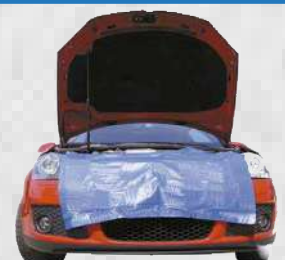

ELEKTRIČARSKI ALAT 1000V VDE



Ključ za ormar krstasti

Odvijači za električare svih oblika i dimenzija

KLEŠTA SVIH OBLIKA I NAMENA



Klešta papagaj sa quatrogrip sistemom i dugmetom za pomeranje čeljusti

Klešta ključ sa paralelnim čeljustima i ovorom do 53 mm

Klešta za seger osigurače

Pincete

Made in Germany

PROFESIONALNI RUČNI ALAT



Mikroelektroničarska klešta svih oblika i namena

Armiračka klešta dužine 280

Klešta dvoručna za sečenje armature

Odvijači svih profila i dimenzija sa ergonomskim rukohvatom

Makaze za sečenje lima debljine do 1,2 mm

Klešta za sečenja kablova većih prečnika sa mehanizmom

Made in Germany

PROFESIONALNI RUČNI ALAT

Nož za skidanje izolacije sa šteljućim sečivom



Rukavice izolovane za nožaste osigurače



Striperi svih oblika za skidanje izolacije na provodnicima svih dimenzija



Višenamenska klešta za krimpovanje svih oblika papučica, hilzni, stopica



Garnitura profesionalnog alata u kožnoj torbi sa metalnim kopčama



Klešta za sečenje kablova većih prečnika



Klešta za sečenje žice svih dimenzija



KLEŠTA ZA KRIMPOVANJE

Alat električarski u metalnom koferu



Klešta za cevi prava i kosa svih dimenzija



Klešta za falcovanje lima



Kofer sa pregradama za odlaganje alata sa mehanizmom zaključavanja



AKUMULATORSKE PRESE ZA KRIMPOVANJE

Baterijska presa za krimpovanje konektora sa izmenjivim ulošcima od 10-240 mm²

Baterijska presa za krimpovanje konektora sa izmenjivim ulošcima od 10 do 300 mm²



Ulošci za krimpovanje za sve tipove materijala



HAUPA Smart-Line

Hidraulična presa za krimpovanje konektora sa izmenjivim nastavcima



Pneumatski alat za pravljenje otvora u limu sa izmenjivim ulošcima od 15,2 do 63,5 mm



POTROŠNI ELEKTRIČARSKI ALAT

Sve vrste stopica, hilzni, papučica, auto konektora



Izolir trake različitih širina, dužina i boja



Veziće plastične svih dimenzija otporne na toplotu



Uvodnici svih dimenzija





BOSCH

AKUMULATORSKJE I ELEKTRIČNE MAŠINE

Sve vrste i oblici akumulatorskih odvijača sa dugotrajnom Li-Ion baterijom

Vibracioni čekići sa SDS-max prihvatom velike snage

Udarni odvrttači snažni sa ergonomskim rukohvatom i dugotrajnim baterijama



best **Metal**

best **Inox**

Merni instrumenti za merenje razdaljine, površine i zapremine



MULTICONSTRUCTION

ČETKICE ZA ELEKTRIČNE MAŠINE



ASEIN

UREĐAJ ZA CENTRIRANJE TRAPA

- 3D reglaže trapa (putnički/teretni program)
- Reglaže trapa sa CCD sensorima (putnički i teretni program)
- Sva oprema je izrađena u Italiji
- Prenos podataka bluetooth vezom



3D prikaz

Komputerski program koji se koristi za reglažu trapa prikazuje vozilo u 3D-u.



Baza podataka

Baza podataka sadrži podatke za više od 90,000 vozila, i ona se može povećavati ručnim ubacivanjem novih vozila.



Bluetooth

Prenos podataka između mernih glava i glavne konzole sse vrši preko Bluetooth tehnologije.



Četvorostubne dizalice

Elektrohidraulične četvorostubne dizalice, nosivost od 3,500-8,000 kg, automatski mehanički zaštitni sistem od propadanja tereta, veliki razmak između stubova omogućava podizanje teretnih vozila.

Reglaža trapa sa CCD sensorima

Standardne reglaže trapa sa CCD sensorima 4-6-8 CCD-a, kablovskim ili Bluetooth prenosom podataka između prednjih mernih glava i komandne konzole, za putnički i teretni program.

Dizalice za reglažu trapa

Unapred predodređene dizalice za upotrebu sa mašinama za reglažu trapa, nosivost od 3,000-5,000 kg.



HOMOLOGACIJA SVETSKIH PROIZVOĐAČA VOZILA



Dvostubne dizalice

Elektromehaničke dvostubne dizalice sa 1 ili 2 motora, nosivost od 2,700-5,000 kg, prenos između stubova se vrši preko kardanskog vratila - velika dugotrajnost sa malo održavanja.

Dvostubne dizalice

Elektromehaničke dvostubne dizalice sa 2 motora, nosivost od 2,700-5,000 kg, sa elektro-mehaničkom sinhronizacijom između stubova.

Makazaste dizalice

Nosivosti od 2,500-5,000 kg, određeni modeli su predodređene za upotrebu sa reglažom trapa, mogućnošću ugrađivanja u pod, dizalica na dizalici.



Dvostubne dizalice za teretni program

Elektromehaničke dvostubne dizalice sa 2 motora, nosivost od 3,700-5,000 kg, sa elektro-mehaničkom sinhronizacijom između stubova i četiri simetrične trostepene pomoćne ruke dužine 1800 mm koje omogućavaju podizanje vozila velikih gabarita. Namenjena za teretna vozila većih gabarita poput Mercedes Sprinter-a, VW Crafter-a.



TEŠKI TERETNI PROGRAM

Elektrohidraulična mašina za montiranje/demontiranje pneumatika na teškim teretnim vozilima

Namenjena za montažu pneumatika do 2550 mm, potpuno bežična komunikacija sa kontrolnom jedinicom. Potpuno automatsko kretanje i montaža pneumatika. Automatsko gašenje mašine nakon nekorišćenja od 5 sekundi.



11" - 43"
11" - 66"
(+G108A12)

2550 mm
(100")

1500 mm
(59")



Dizalice sa mobilnim stubovima

Elektromehaničke dizalice sa mobilnim stubovima, nosivost po stubu od 3,000-10,000 kg, automatsko i neprekidno podmazivanje vretena, elektronska sinhronizacija između visine stubova, glavni stub na sebi poseduje sve komande, nekoliko režima rada - istovremena upotreba svih stubova, istovremena upotreba jednog ili više pari stubova, pojedinačna upotreba svakog stuba.



SERIJA

Nosivost po stubu

4 stubova		6 stubova		8 stubova	
SM	kg	SM	SM	SM	SM
2100	3000	2104	2108	2108	2108
2200	4000	2204	2208	2208	2208
2300	5500	2304	2308	2308	2308
2400	7000	2404	2408	2408	2408
2600	8500	2604	2608	2608	2608
2700	10000	2704	2708	2708	2708

VULKANIZERSKA OPREMA

Mašina za montiranje/demontiranje guma

Jednostavno i brzo montiranje i demontiranje guma sa felni, sa uređajima za naduvavanje tubeless guma.



	IN	OUT
GA2645.30	10°-33"	8°-30"
GA2645.28	12°-30,5"	10°-28"
GA2645.26	12°-28,5"	10°-26"
GA2645.22	13°-24,5"	11°-22"
GA2645.20	12°-22,5"	10°-20"
GA2645.18	12°-20,5"	10°-18"
GA2645V.30	10°-33"	8°-30"
GA2645V.28	12°-30,5"	10°-28"
GA2645V.26	12°-28,5"	10°-26"
GA2645V.22	13°-24,5"	11°-22"
GA2645V.20	12°-22,5"	10°-20"
GA2645V.18	12°-20,5"	10°-18"
GA2645D.30	10°-33"	8°-30"
GA2645D.28	12°-30,5"	10°-28"
GA2645D.26	12°-28,5"	10°-26"
GA2645D.22	13°-24,5"	11°-22"
GA2645D.20	12°-22,5"	10°-20"
GA2645D.18	12°-20,5"	10°-18"

Mašina za balansiranje točkova LCD displej u boji, prečnik felne 10"-26", širina felne 1,5"-22", max težina točka 70 kg, preciznost 1g.



Pegla za gume

Snaga 600 W, regulacija temperature 140-180°C, maksimalan otvor 100 mm, grejna ploča 190x100 mm.



KLIMA STANICE

Uređaj za punjenje klima u vozilima

Kompletno automatski uređaj za punjenje klima za putnički i teretni program, upotreba gasa **R134a** kao i mogućnost upotrebe novog gasa **R1234YF**, manualni manometri (model 01.030.00), digitalni manometri (model 01.030.04), ugrađena baza podataka sa svim informacijama vezano za vozila, mogućnost ispiranja A/C sistema, mogućnost štampanja izveštaja.



STARTER-BOOSTER



Kada za ultrazvučno čišćenje dizni i ostalih metalnih delova

Kapacitet rezervoara 2,75 l, dimenzije rezervoara 240x137x100 mm, ultrazvučna snaga 150 W, broj enkodera 1, frekvencija 38 kHz, snaga grejanja 200 W,



Uređaj za dezinfekciju ventilacije u vozilima

Ultrazvučno uništavanje bakterija u klimama u vozilima (streptokoke, ešerihija koli...), 220V-50/60Hz, 2 automatska tajmera, senzor za min/max nivo, težina 3,5 kg.



SISTEMI ZA EKSTRAKCIJU GASOVA

Prenosni uređaj za ekstrakciju gasova nastalih u procesu zavarivanja

Snaga motora 1,5 HP, veoma fleksibilan i mobilan, visoke performanse, dužina odsisne ruke 3,0 m, max usisna moć 1,400 m³/h.



Rolna sa crevom i ventilatorom za odsisavanje izduvnih gasova za putnički i teretni program
Crevo dužine od 7,5 do 13 m, prečnik creva od 75 do 200 mm, za temperature do 200°C.



Šina sa crevima za izduvnih gasova

Aluminijumska šina klizačima, dužina šine od dužina creva 7,5 m, max 200° C, snaga ventilatora / 2,2 kW.



odsisavanje

XTK1 sa 12 do 30 m, temperatura latora od 3



Istakalice za ulje

Kombinovane istakalice za ulje (vakumski i gravitaciono izvlačenje ulja) sa kapacitetom rezervoara od 65-90 litara, sa menzutom, posudom za hvatanje ulja, različitim sondama za lakše izvlačenje ulja.



Mobilna kolica za ulje

Kolica opremljena sa pneumatskom pumpom i digitalnim pištoljem za sipanje ulja direktno iz buradi kapaciteta 50-60 i 180-200 litara. Dužina creva 5 m, pumpe sa odnosom od 4:1 ili 6:1.

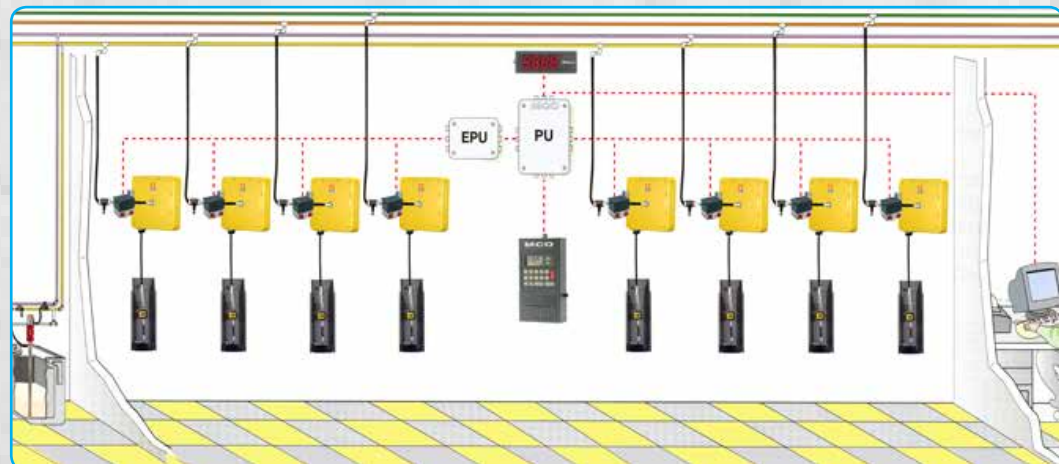

MAŠINE ZA OBRADU KOČNICA



Mašina za obradu kočionih obloga

Obrada kočionih obloga direktno na vozilu.

- Automatski posmak
- Jednostavno podešavanje prečnika obrade
- Uređaj za "meki start"
- Broj obrtaja: 90 o/min
- Posmak: 0,6 mm/obr
- Min prečnik obrade: 230 mm
- Max prečnik obrade: 480 mm
- Max dubina kočione obloge: 290 mm
- Težina: 160 kg



Mašina za obradu kočionih diskova

Obrada kočionih diskova direktno na vozilu.

- Max prečnik obrade: 500 mm
- Min prečnik obrade: 120 mm
- Max debljina diska: 65 mm
- Max radna širina: 140 mm
- Broj obrtaja: 60 o/min
- Podesivi posmak: 0-0,3 mm/obr
- Snaga motora: 2 HP (1,5 kW)
- Dimenzije: 850x650x1050 mm
- Težina: 232 kg

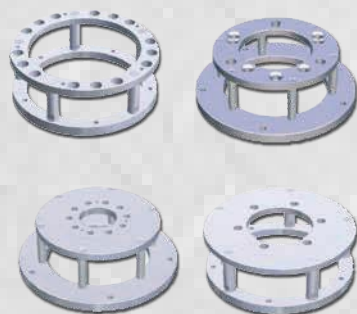

Mašina za punktovanje

Hidro-pneumatsko punktovanje svih kočionih obloga.

- Prečnik nitni: 3-12 mm
- Radni pritisak: 1-8 bar
- Max udarna sila: 5200 kg
- Max hod: 40 mm
- Dimenzije: 350x490x1520 mm
- Težina: 134 kg

Adapteri za sve vrste osovina (TD 502)

Razni tipovi adaptera za punktovanje

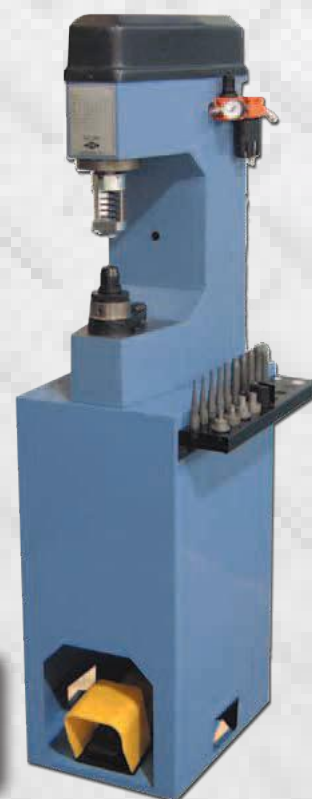

FILTERSKE JEDINICE

AIRCOM filterske jedinice

Filterske jedinice velikog kapaciteta. Karakteristike:

- Protok vazduha: 2,500 m³/h
- Površina filtriranja: 34 m²
- Broj filterskih uložaka: 36
- Tip filterskih uložaka: Poliester PES500/TF
- Dimenzije uložaka: \varnothing 125 mm H=2500 mm
- Broj elektroventila: 6x1"
- Tip elektroventila: Potpuno uranjajući 24V DC
- Komprimovani vazduh: od 4 do 6 bar
- Ukupne dimenzije: 1150x1150x7200 mm



SOUND-PROOF BOX

Izrada zvučno-izolacionih kutija za ventilatore koji u velikoj meri smanjuje nivo buke.



Sve vrste filterskih uložaka



CORAL

Oprema za ekstrakciju i filtraciju vazduha u industriji. Veliki izbor pojedinačnih stacionarnih stanica za odvod gasova, kao i multifunkcijski sistemi za više radnih mesta u procesima zavarivanja, prehrambenoj, hemijskoj industriji...



NAJEKONOMIČNIJI KLIMA UREĐAJ

M50

Klima uređaj COOLERADO M50 isporučuje potpuno svež i hladan spoljni vazduh očišćen od prašine, polena i drugih alergena uz uštedu i do 90% električne energije u odnosu na standardne kompresorske klima uređaje.

Pri svom radu koristi patentiranu tehnologiju za razmenu toplote i mase (HMX), inovativnom metodom hlađenja uz korišćenje samo vode i bez upotrebe ikakvih hemijskih sredstava kao što je freon koji uništava ozonski omotač i doprinosi globalnom zagrevanju. Zbog toga su smanjeni troškovi održavanja i uz veliku uštedu električne energije ovi uređaji sami sebe brzo otplaćuju.

Kućište klima uređaja izrađeno je da pored jednostavne montaže omogućuje i modularno povezivanje više jedinica bez ikakvog međuprostora čime se povećava rashladni kapacitet u zavisnosti od potreba korisnika.



PRINCIP RADA

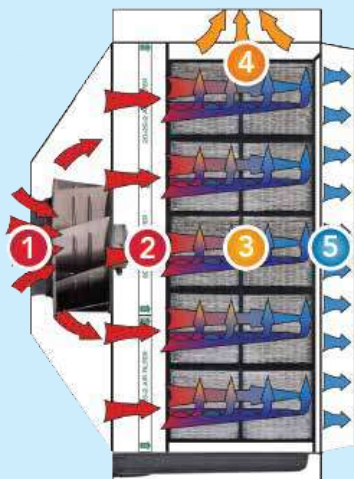

- 1 ULAZNI VAZDUH** Spoljašnji vazduh se uvlači unutra pomoću ventilatora.
- 2 FILTRIRANJE** Vazduh se zatim filtrira.
- 3 RAZMENA TOPLOTE I MASE** Vazduh ulazi u sklop HMX-ova koji koriste patentiranu tehnologiju.
- 4 OBRADA VODE I VAZDUHA** Otprilike pola vazduha koji uđe u HMX je zasićen vodom i vraća se u atmosferu, odnoseći toplotu iz klima uređaja.
- 5 RASHLAĐENI VAZDUH** Druga polovina vazduha koji uđe u HMX je rashlađen bez dodavanja vlage.

COOLERADO JE ZELEN

Zeleno za vaš budžet



Coolerado klima uređaji koriste i do 90% manje energije u odnosu na konvencionalne kompresorske klima uređaje.

Zeleno za planetu



Coolerado Klima Uređaji su odgovoran izbor za prirodno okruženje, bez upotrebe hemijskih supstanci.

Zeleno za vaše zdravlje



Coolerado klima uređaji isporučuju 100% svež, isfiltriran vazduh, uz značajno poboljšanje kvaliteta vazduha.



Altema d.o.o.

ALTEMA DOO

Privredno društvo za unutrašnju i spoljnu trgovinu

Adresa: Starca Vujadina 6
11000 Beograd
Srbija

Telefoni: 011/311-5119
011/770-4414
062/208-110
062/208-120

Fax: 011/311-5119
E-mail: office@altema.rs
Web: www.altema.rs

- PROFESIONALNI RUČNI ALAT
- SERVISNA OPREMA
- SISTEMI ZA EKSTRAKCIJU GASOVA

